





Scale	Dwg type	Total weight	kg						
1:2	Dwg size	Material weight	kg	Rev.	Times	Change	Date	Name	
	A4P								
Measures mm	Surface texture	General tolerance	Drawn					Dwg No. P150	
	Ra (um)		Check.						
			Appr.						
Valmistus1	Part	pcs	Job No.	Description					
Belongs to				Pulttikiinnike, kiinnitysväli 150mm					
Man. Code									
OEM Code									



SECTION A-A
SCALE 1 : 2

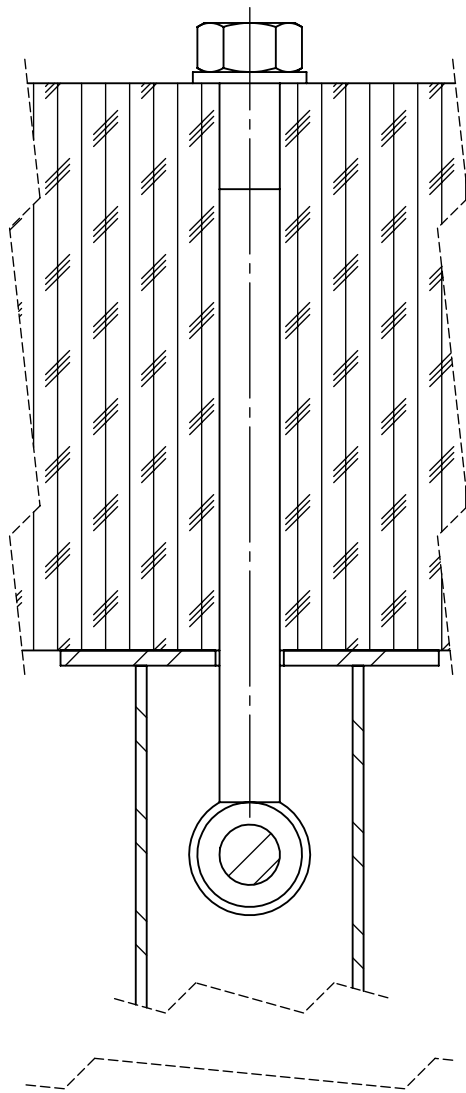
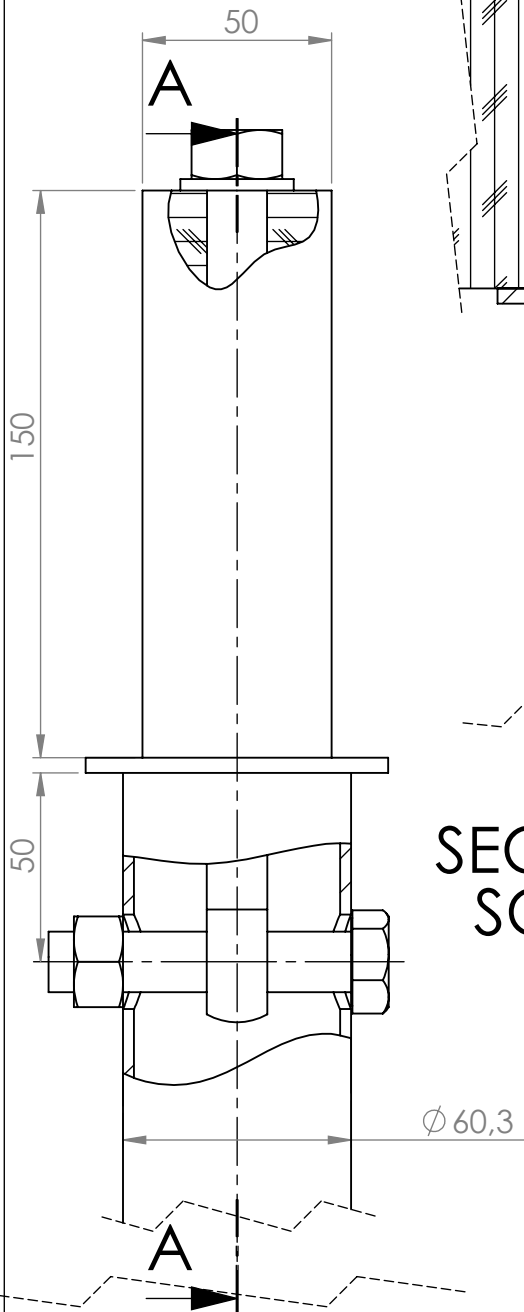
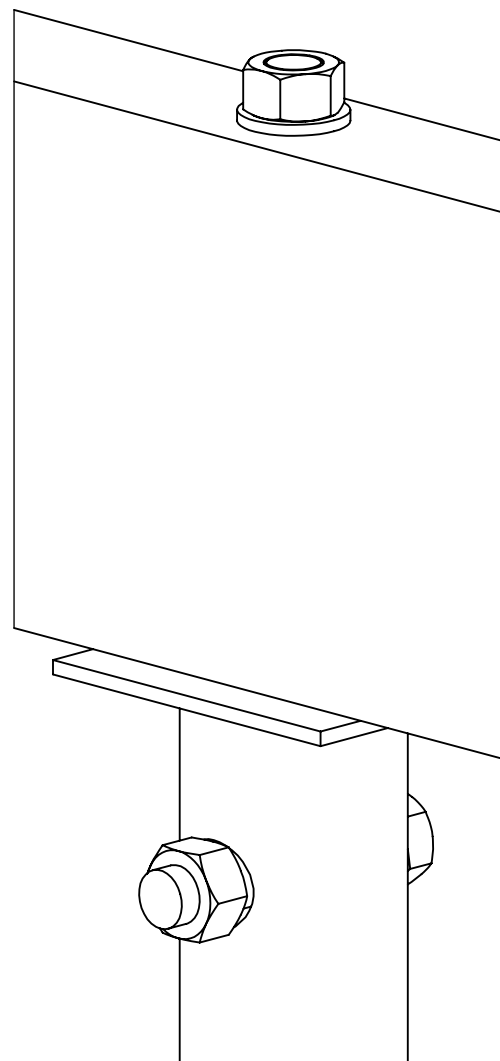

Scale	Dwg type	Total weight	kg						
1:2	Dwg size	Material weight	kg	Rev.	Times	Change	Date	Name	
	A4P								
Measures mm	Surface texture	General tolerance	Drawn					Dwg No. P150	
	Ra (um)		Check.						
			Appr.						
Valmistus2		Part	pcs	Job No.	Description				
Belongs to					Pulttikiinnike, kiinnitysväli 150mm				
Man. Code									
OEM Code									